



# TECHNICAL INFORMATION

## SMT PROCESS CHARACTERISTICS OF AVX TRANSGUARDS

by Ron Demko  
AVX Corporation  
Raleigh, NC

### **Abstract:**

TransGuards are uniquely suited for wide-scale usage in SMT applications. TransGuards exhibit many advantages when used in SMT assemblies.

This paper is a general guideline aimed at familiarizing users with the characteristics of soldering multilayer SMT ZnO TransGuards.

# SMT PROCESS CHARACTERISTICS OF AVX TRANSGUARDS

by Ron Demko  
AVX Corporation  
Raleigh, NC

## Introduction

### General Description

The AVX TransGuard Transient Voltage Suppressor (TVS) with unique high-energy multilayer construction represents state-of-the-art overvoltage circuit protection. Monolithic multilayer construction provides maximum protection from voltage transients caused by ESD, lightning, NEMP, inductive switching, etc. True surface mount product is provided in industry standard packages. Thru-hole components are supplied as conformally coated axial devices.

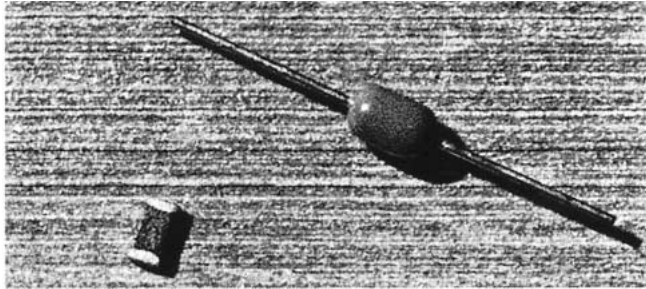

### TransGuard Description

TransGuards are zinc oxide (ZnO) based ceramic semiconductor devices with extremely non-linear current-voltage characteristics similar to back-to-back zener diodes. They have the added advantage of much greater current and energy handling capabilities. Devices are fabricated by a ceramic sintering process that yields a structure of conductive ZnO grains surrounded by electrically insulating barriers, creating varistor-like behavior.

The number of grain-boundary interfaces between conducting electrodes determines "Breakdown Voltage" of the device. High voltage applications such as AC line protection require many grains between electrodes while low voltage requires few grains to establish the appropriate breakdown voltage. Single layer ceramic disc processing proved to be a viable production method for thick cross section devices with many grains, but attempts to address low voltage suppression needs by processing single layer ceramic disc formulations with huge grain growth has had limited success.

AVX, the world leader in the manufacture of multilayer ceramic capacitors, now offers the low voltage transient protection marketplace a true multilayer, monolithic surface mount varistor. Technology leadership in processing thin dielectric materials and patented processes for Precise ceramic grain growth have yielded superior energy dissipation

in the smallest size. Now a varistor has voltage characteristics determined by design and not just cell sorting whatever falls out of the process.

## TransGuard Surface Mount Devices

The move toward SMT assembly of Transient Voltage Suppressors (TVS) will continue accelerating due to improved long-term reliability, more efficient transient voltage attenuation and size/functionality/cost issues.

TransGuards are uniquely suited for wide-scale usage in SMT applications. TransGuards exhibit many advantages when used in SMT assemblies. Among them are:

- Available in true EIA chip sizes 0805/1206/1210.
- Placed with standard equipment (8mm tape and reel).
- Processed with fewer guidelines than either ceramic chip or resistor chip devices.
- Exhibit the highest energy/volume ratio of any EIA size TVS.

This paper is a general guideline aimed at familiarizing users with the characteristics of soldering multilayer SMT ZnO TransGuards.

Due to the semiconducting nature of the doped Zinc Oxide (ZnO) ceramic material, SMT TransGuards are not suitable for plated nickel termination. The entire chip becomes plated with nickel rather than just the termination. Therefore, AVX uses a platinum-enhanced palladium silver (PdPtAg) thick film termination (called out by DESC drawing 90096). This termination allows TransGuards to be processed on wave, infrared reflow, and vapor phase assembly lines. For optimum performance, EIA standard solder pads (land areas) shown in Figure 1 are recommended regardless of the specific attachment method.

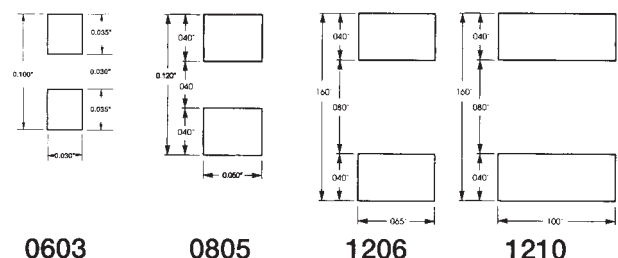

Figure 1. TransGuard Solder Pad Dimensions

# TransGuard Process Guidelines

AVX TransGuards are easy to process with less restrictions than MLC capacitors, chip resistors and other surface mount components. The following solderability profiles are suggested for the different soldering techniques.

## Wave Soldering

Wave soldering has the highest solder temperatures and heat transfer rates whose temperature limits are determined by parts like transistors and integrated circuits. The profile has a short dwell time in the solder pot and requires a high preheat to minimize thermal shock in ceramic components and temperature problems with resin-molded parts.

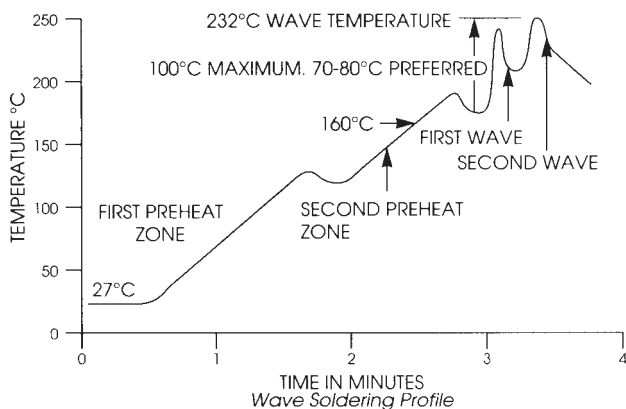

Figure 2. Wave Soldering Temperature Profile

## Vapor Phase Temperature Profile

Vapor phase soldering has the second highest heat transfer rate so care must be used. Preheating the assembly and minimizing the dwell time above the solder liquidus temperature are needed to help reduce defects.

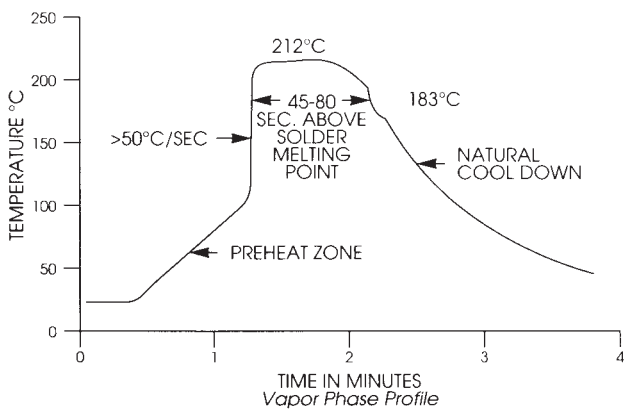

Figure 3. Vapor Phase Temperature Profile

## Infrared Reflow Soldering (IR)

Soldering with IR has the highest yields due to controlled heating rates and solder liquidus times. Only the dwell time and peak temperature limitations of resin-molded components need to be considered. Typical recommended solder paste wet laydown is 10-15 mils.

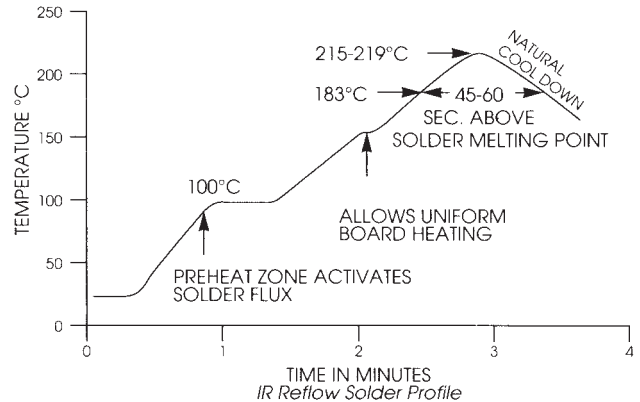

Figure 4. Infrared Reflow Temperature Profile

## Inspection Criteria

The TransGuard PdPtAg termination will always exhibit a dull color and smaller fillet height than a nickel barrier component. Typically, TransGuards will have a 30% to 50% fillet height as shown in Figure 5.

Fillet height variations are due to the colloidal surface tension and wetting characteristics of the PdPtAg material system.

**THE FILLET HEIGHT VARIATIONS RELATIVE TO NICKEL ARE NOT DUE TO PROCESS PROBLEMS OR TERMINATION INTEGRITY**

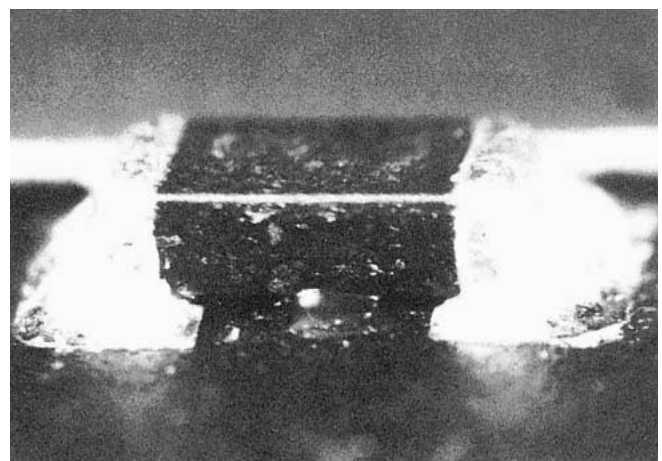

Figure 5. Typical TransGuard Solder Fillet Height 30% to 50%

The recommended visual inspection criteria for TransGuards are shown in Figure 6.

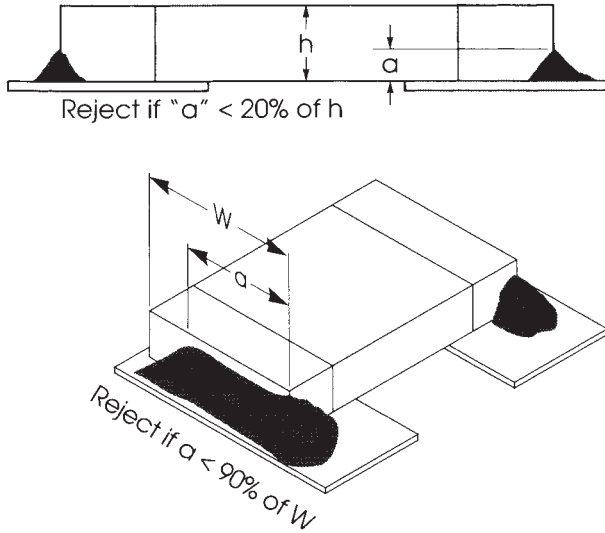

Figure 6. TransGuard Visual Inspection Criteria

The factors used in determining the visual inspection criteria were lateral push strength, thermal shock/humidity tests and long-term life tests. Details of each test cell follow:

### Lateral Push Strength

The lateral push strength of TransGuards which exhibited a solder fillet from 30% to 50% was tested with a linear force Chatillion DPP-25 gauge placed across the ZnO body area. The lateral push strength of five (5) pounds called for by military hybrid requirements was used as a pass/fail criterion.

Several lots of 0805, 1206 and 1210 size TransGuards were processed with both wave solder and IR reflow attachment methods. Both FR4 and alumina substrates were used in the test.

Results of the push test showed all test cells to greatly exceed the military requirement of five (5) lbs. regardless of the attachment method or substrate (See Figure 7).

#### LATERAL PUSH TESTS TRANSGUARD

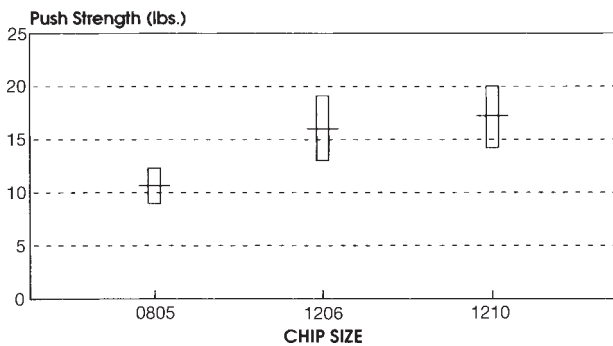

Figure 7. Lateral Push Strength with 30% to 50% Fillet

Additionally, TransGuards exceeded military push strength requirements when repeatedly passed through the soldering (IR) operation. A comparison between TransGuards PdPtAg termination push strength and a Ni barrier ceramic chip capacitor push strength is shown in Figure 8.

#### LATERAL PUSH TEST PdPtAg vs Ni BARRIER TERMINATION

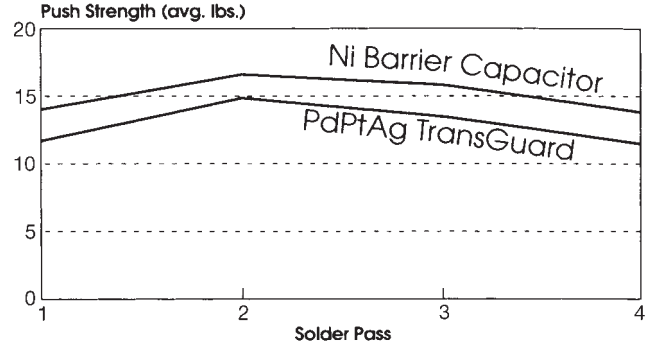

Figure 8. Lateral Push Strength Comparison PdPtAg vs. Ni Barrier

### Thermal Shock and Humidity

Thermal Shock and Humidity testing was used to evaluate the TransGuard Solder fillet integrity and material system performance in a 90%-95% RH environment for 100 hours. Test methods and requirements are shown below. TransGuards exhibited zero failures in both the Thermal Shock and Humidity segments of the test.

#### Thermal Shock and Humidity Test Method:

TransGuards shall be subjected to five (5) temperature cycles per Method 107, test condition A of MIL-STD- 202F except that in Step 3, sample units shall be tested at the maximum rated temperature. TransGuards shall then be subjected to a temperature of  $40 \pm 2^\circ\text{C}$  and a relative humidity of 90 to 95% for  $100 \pm 4$  hours. Final measurements of forward voltage shall be made as specified not more than 30 minutes after removal from the moisture chamber.

#### Requirements:

Forward Voltage Change:  $\leq \pm 10\%$  maximum.

## Long-Term Life Tests

AVX regularly places numerous groups of TransGuards on accelerated life tests at 125°C, 85% rated voltage for 1000 hours. TransGuards have never experienced an intermittent or a failure as a result of poor solder fillet of the termination material system. Long-term life test methods and requirements are as follows:

### Long-Term Life Test Method:

TransGuards shall be tested in accordance with Method 108 of MIL-STD-202. The following details and exceptions apply:

- (a) Distance of Temperature Measurement from Specimen: Not applicable.
- (b) Test Temperature: Tolerance and Test Voltage: 125°C +4, -0°C at rated voltage.
- (c) Operating Conditions: 50mA maximum surge current and rated voltage.
- (d) Test Time: 1000 hours +48, -0 hours.
- (e) Final Measurements: Forward voltage shall be measured as specified.

### Requirements:

Forward Voltage Change:  $\leq \pm 10\%$  maximum.

## Conclusion

AVX TransGuards can be processed with standard industry attachment methods in high volume, highly automated conditions. A full understanding of visual inspection criteria helps users to properly classify solder fillets of this revolutionary device. Widespread acceptance of TransGuards reinforces reliability of this device in commercial, military and avionics equipment.

## References

1. J. Maxwell, N. Chan, A. Templeton - *A Multilayer Approach to Transient Voltage Suppression*. AVX Technical Information Series.
2. R. Demko, N. Chan, A. Templeton - "Miniaturized Multilayer Varistors for Transient Voltage Suppression" *CARTS European Proceedings*, October 1991.
3. Staff Authors - "TransGuard Termination Performance During Surface Mount Soldering", AVX 1989.
4. N. Dixon - "Environmental Performance Summary of Multilayer ZnO Devices", AVX 1991.

NOTICE: Specifications are subject to change without notice. Contact your nearest AVX Sales Office for the latest specifications. All statements, information and data given herein are believed to be accurate and reliable, but are presented without guarantee, warranty, or responsibility of any kind, expressed or implied. Statements or suggestions concerning possible use of our products are made without representation or warranty that any such use is free of patent infringement and are not recommendations to infringe any patent. The user should not assume that all safety measures are indicated or that other measures may not be required. Specifications are typical and may not apply to all applications.

## USA

### AVX Myrtle Beach, SC Corporate Offices

Tel: 843-448-9411  
FAX: 843-626-5292

### AVX Northwest, WA

Tel: 360-699-8746  
FAX: 360-699-8751

### AVX North Central, IN

Tel: 317-848-7153  
FAX: 317-844-9314

### AVX Mid/Pacific, MN

Tel: 952-974-9155  
FAX: 952-974-9179

### AVX Southwest, AZ

Tel: 480-539-1496  
FAX: 480-539-1501

### AVX South Central, TX

Tel: 972-669-1223  
FAX: 972-669-2090

### AVX Southeast, NC

Tel: 919-878-6223  
FAX: 919-878-6462

### AVX Canada

Tel: 905-564-8959  
FAX: 905-564-9728

## EUROPE

### AVX Limited, England European Headquarters

Tel: ++44 (0) 1252 770000  
FAX: ++44 (0) 1252 770001

### AVX S.A., France

Tel: ++33 (1) 69.18.46.00  
FAX: ++33 (1) 69.28.73.87

### AVX GmbH, Germany - AVX

Tel: ++49 (0) 8131 9004-0  
FAX: ++49 (0) 8131 9004-44

### AVX GmbH, Germany - Elco

Tel: ++49 (0) 2741 2990  
FAX: ++49 (0) 2741 299133

### AVX srl, Italy

Tel: ++390 (0)2 614571  
FAX: ++390 (0)2 614 2576

### AVX Czech Republic, s.r.o.

Tel: ++420 (0)467 558340  
FAX: ++420 (0)467 558345

## ASIA-PACIFIC

### AVX/Kyocera, Singapore Asia-Pacific Headquarters

Tel: (65) 258-2833  
FAX: (65) 350-4880

### AVX/Kyocera, Hong Kong

Tel: (852) 2-363-3303  
FAX: (852) 2-765-8185

### AVX/Kyocera, Korea

Tel: (82) 2-785-6504  
FAX: (82) 2-784-5411

### AVX/Kyocera, Taiwan

Tel: (886) 2-2696-4636  
FAX: (886) 2-2696-4237

### AVX/Kyocera, China

Tel: (86) 21-6249-0314-16  
FAX: (86) 21-6249-0313

### AVX/Kyocera, Malaysia

Tel: (60) 4-228-1190  
FAX: (60) 4-228-1196

### Elco, Japan

Tel: 045-943-2906/7  
FAX: 045-943-2910

### Kyocera, Japan - AVX

Tel: (81) 75-604-3426  
FAX: (81) 75-604-3425

### Kyocera, Japan - KDP

Tel: (81) 75-604-3424  
FAX: (81) 75-604-3425

Contact:



<http://www.avxcorp.com>

S-SMT00M301-R